



OEM SOLUTIONS









The “Standard” for all automatic print & apply Labeling



M8485Se - High Speed OEM Printer

The M8485Se is the “standard” print engine used in print apply applications around the world. With its 5" print width and maximum print speed of 12 inches per second, the M8485Se is your first choice for high-speed labeling applications.

The industrial OEM high-speed printers are ideal for a range of applications, including:

-  **Compliance Labeling**
-  **Warehouse Logistics**
-  **Pallet Tracking**
-  **Retail Labeling**
-  **Product Authentication**
-  **Cross-Docking**
-  **Shipping Labels**
-  **Weigh-Scale Labeling**
-  **RFID Labeling (optional)**

Throughput

The M8485Se continues to set the benchmark for OEM printer performance in automatic label applicator systems. Utilizing the latest in 32-bit microprocessor technology, along with 16 MB of standard RAM, the M8485Se provides virtually instantaneous “time to first label out”. When printing at its maximum speed of 12 ips, the M8485Se is capable of handling your most demanding automatic print apply application, especially those where data changes on every label.

Interchangeable

The height, width and location of mounting holes are identical to earlier SATO OEM print engines, making it easy to upgrade to the M8485Se. Plus, the M8485Se is compatible with the programming commands for the M8400S and the M8485S, making it a simple drop-in replacement.

Host Interface Flexibility

Designed with a modular interface slot, the M8485Se allows for a wide variety of interface options to be easily installed and field upgraded. These bi-directional interfaces include a high-speed IEEE1284 Parallel (ECP), RS232C Serial, 10BaseT/100BaseTX Ethernet and 802.11g Wireless Ethernet.

Legendary Reliability

Your labeling application is demanding and uptime is paramount. The M8485Se was designed to provide reliable performance over extended periods of time. It was specifically developed as a high-duty cycle applicator print engine...it is not a repackaged desktop printer. Even the heavy gauge steel enclosure was designed for production environments. Yet, internal access for maintenance is simple.



SPECIFICATIONS



M8485Se	
Printing Method	Thermal Transfer/Direct Thermal
Print Resolution	203 dpi (8 dots/mm)
Print Speed	Up to 12"/s (300mm/s)
Max. Print Area	5" (128mm) W x 49.2" (1249mm) L
Media Size	Max. 5.27" (134mm) W Min. 1" (25mm) W x 0.24" (6mm) L ⁽¹⁾
Ribbon Size	5.25" (133mm) W x 1968' (600m) L Min. 1.6" (39.5mm) W, Face-In Wind
Dimensions	9.7" W x 16.1" D x 11.7" H (245mm W x 408mm D x 298mm H)
Weight	25 lbs. (11.34 kg)

Memory:

- 16 MB Standard RAM
- 2 MB Standard Flash
- 1 MB PCMCIA - Optional
- 6 MB Optional Flash - Total

Processor:

32-BIT RISC

Media:

Die cut labels, plain paper facestock & synthetics.
Maximum unwind torque: 8 ft./lbs.

Back feed:

Adjustable, ± 10" (255mm)

Sensing:

Transmissive sensor for die cut labels & tags.
Reflective sensor for use with preprinted sensing marks. Automatic, programmable setting to top of form.

External Connector:

Ext. (Applicator I/F): 14-pin Amp

Plug-In Interface Modules:

- Serial - RS232C (up to 57.6k bps)
- Parallel - IEEE1284 (ECP)
- Ethernet - 10BaseT/100BaseTX
- Wireless 802.11g
- RS422/485

Barcode Symbologies:

Linear: UPC-A, UPC-E, EAN-8, EAN-13, Code 39, Code 93, Code 128, Codabar, MSI, Bookland, Industrial 2/5, Interleaved 2/5, Matrix 2/5, Postnet, UCC/EAN 128, RSS, Composite
2-Dimensional: PDF417, Micro PDF417, Truncated PDF417, Maxicode, Data Matrix, QR Code

Fonts:

Bitmap - 12 proportional, mono-spaced and outline fonts (Code table 858). Internal CG Triumvirate & CG Times fonts scalable from 2 to 99 points. Optional downloaded TrueType fonts.

Barcode & Font Formatting:

360° rotation of barcodes and text, character expansion horizontally and vertically, sequential numbering, form overlay for high-speed editing of complex formats.

Graphic Support:

Printing & storage of .PCX, .BMP format, SATO Hex/binary

Software:

Windows® Drivers (Windows® 95, 98, ME, NT4.0, 2000, XP)
"Label Gallery Free" - Label Software
Printer Utilities

Electrical Requirements:

115V/220V (± 10%), 50/60 Hz (± 1%)

Auto-switching

Agency Certifications: CE, UL, CSA, TÜV, FCC Class A

Environmental Requirements:

Operating: 41° to 104°F (5° to 40°C)

15-85% RH, non-condensing

Storage: 23° to 140°F (-5° to 60°C)

Max. 90% RH, non-condensing

Other Features:

- Standard Real Time Clock
- Optional Opposite Hand Models
- Optional 4 MB Flash Memory
- Optional RFID Capability

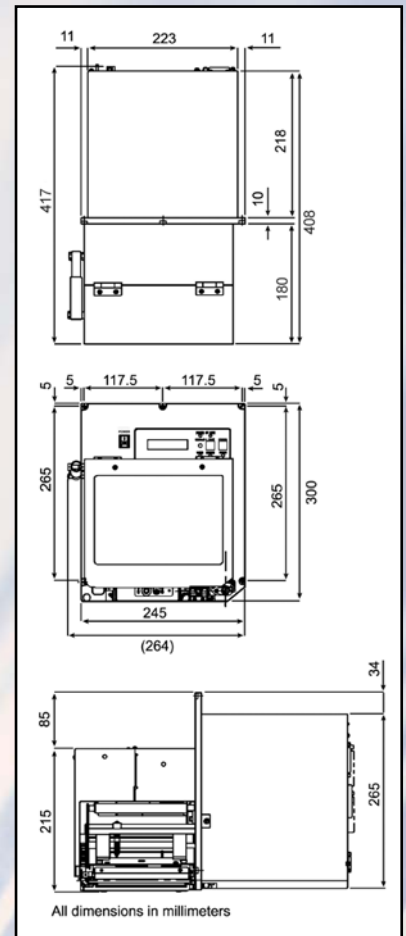

⁽¹⁾Minimum label length at print speeds greater than 6 ips is 1 inch.